

# SILTALA YACHTS

## NAUTICAT 39 ELECTRICAL SYSTEM

HULL No:21

INSTALLED BY LAIVASSAHKOTYO OY  
PO BOX 25 20201 TURKU FINLAND  
Phone: +358 21 306200 Fax: +358 21 306216

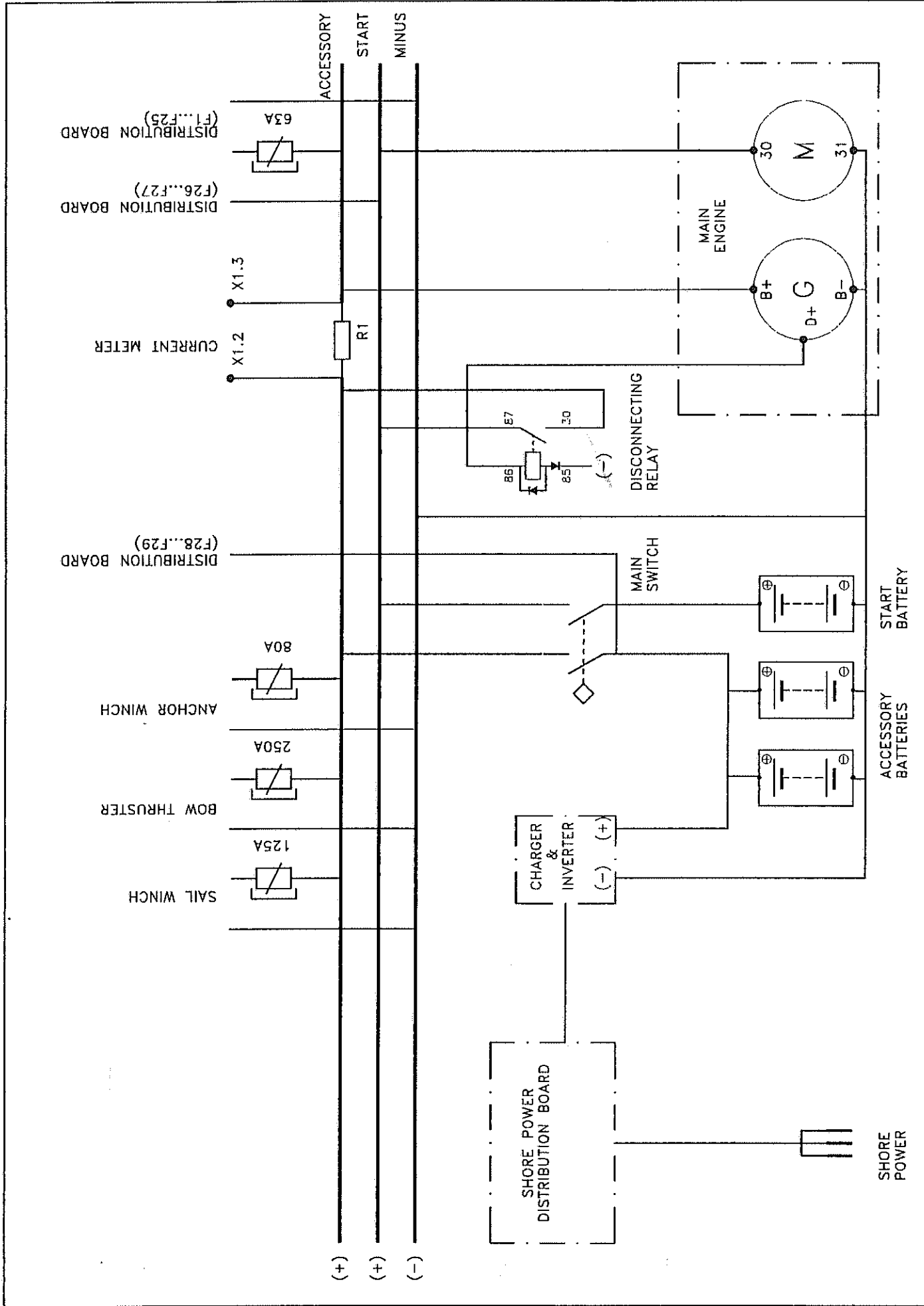

CAD FILE	3201AMD	DRAW	J.P.	SHEET	1 ( )	REVISION
SCALE		DATE	171193	DWS. NO.		
LAIVASÄHKÖYÖ OY				MAIN DIAGRAM		
PO BOX 25 20201 TURKU				SILTALA YACHTS		
Phone: +358 21 306200				NAUTICAT		

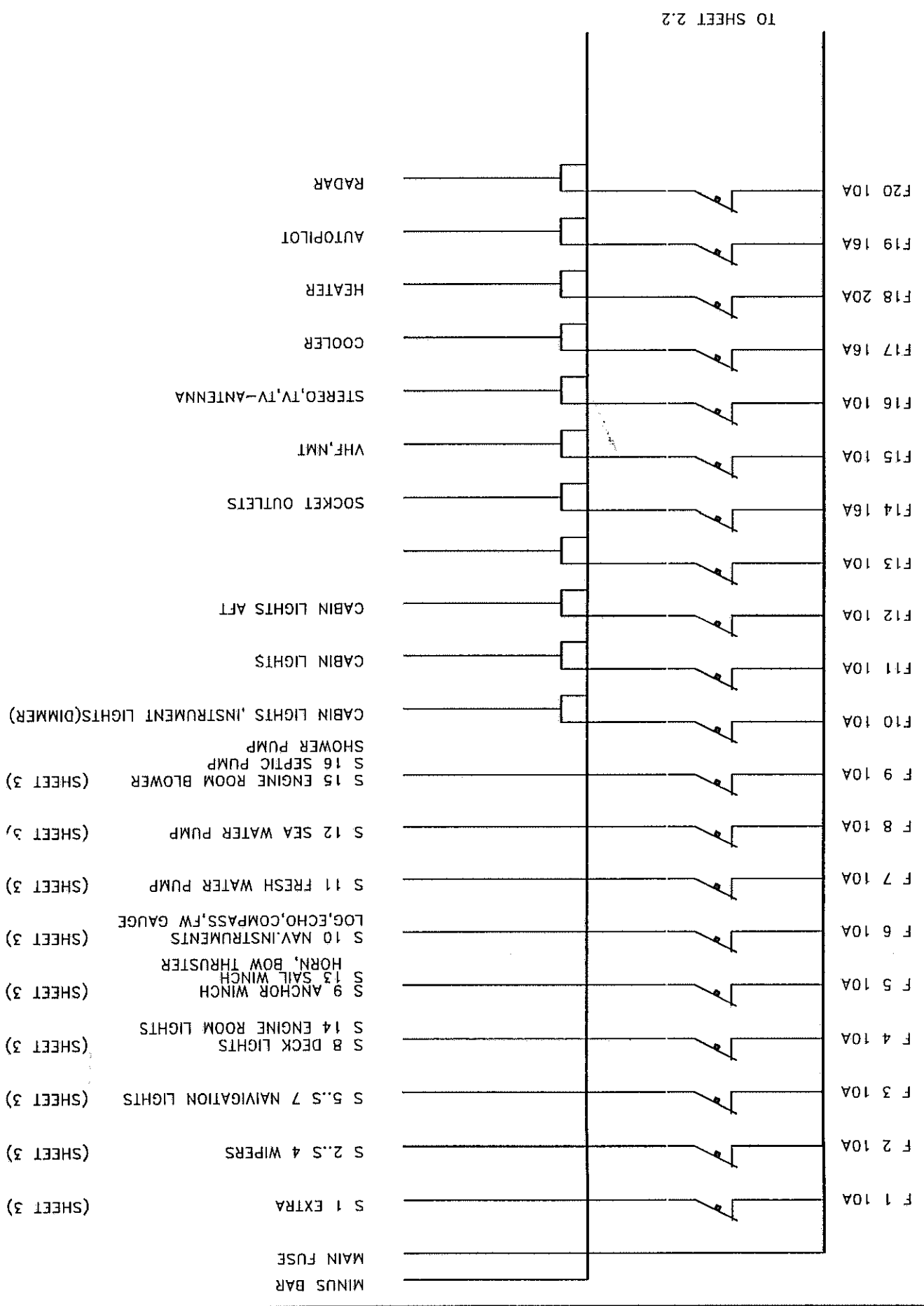

TO SHEET 2.2

MINUS BAR  
MAIN FUSE

(SHEET 3) S 1 EXTRA

(SHEET 3) S 2.S 4 WIPERS

(SHEET 3) S 5.S 7 NAVIGATION LIGHTS

(SHEET 3) S 8 DECK LIGHTS  
S 14 ENGINE ROOM LIGHTS

(SHEET 3) S 9 ANCHOR WINCH  
S 13 SAIL WINCH  
HORN, BOW THRUSTER

(SHEET 3) S 10 NAV. INSTRUMENTS  
LOG, ECHO, COMPASS, FW GAUGE

(SHEET 3) S 11 FRESH WATER PUMP

(SHEET 3) S 12 SEA WATER PUMP

(SHEET 3) S 15 ENGINE ROOM BLOWER  
S 16 SEPTIC PUMP  
SHOWER PUMP

(SHEET 3) CABIN LIGHTS, INSTRUMENT LIGHTS (DIMMER)

CABIN LIGHTS

CABIN LIGHTS AFT

SOCKET OUTLETS

VHF, NMT

STEREO, TV, TV-ANTENNA

COOLER

HEATER

AUTOPILOT

RADAR

F 1 10A

F 2 10A

F 3 10A

F 4 10A

F 5 10A

F 6 10A

F 7 10A

F 8 10A

F 9 10A

F 10 10A

F 11 10A

F 12 10A

F 13 10A

F 14 16A

F 15 10A

F 16 10A

F 17 16A

F 18 20A

F 19 16A

F 20 10A

CAD FILE 3202ADB1

DRAW J.P.  
DATE 100593



LAIVASAHIKOTOYO OY  
PO BOX 25 20201 TURKU  
Phone: +358 21 306200

SILTALA YACHTS  
NAUTICAT DISTRIBUTION BOARD

SHEET 2.1( ) REVISION  
DWG. NO. NC3202ADB

SCALE

CHECK

SHEET 2.2( ) REVISION  
 DWG. NO. NC3202ADB

**SILTALA YACHTS**  
**NAUTICAT**  
 DISTRIBUTION BOARD

LAIVASAHKOTOYO OY  
 PO BOX 25 20201 TURKU  
 Phone: +358 21 306200

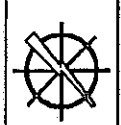

CAD FILE 3202ADB2  
 SCALE  
 DRAW J.P.  
 DATE 100593  
 CHECK

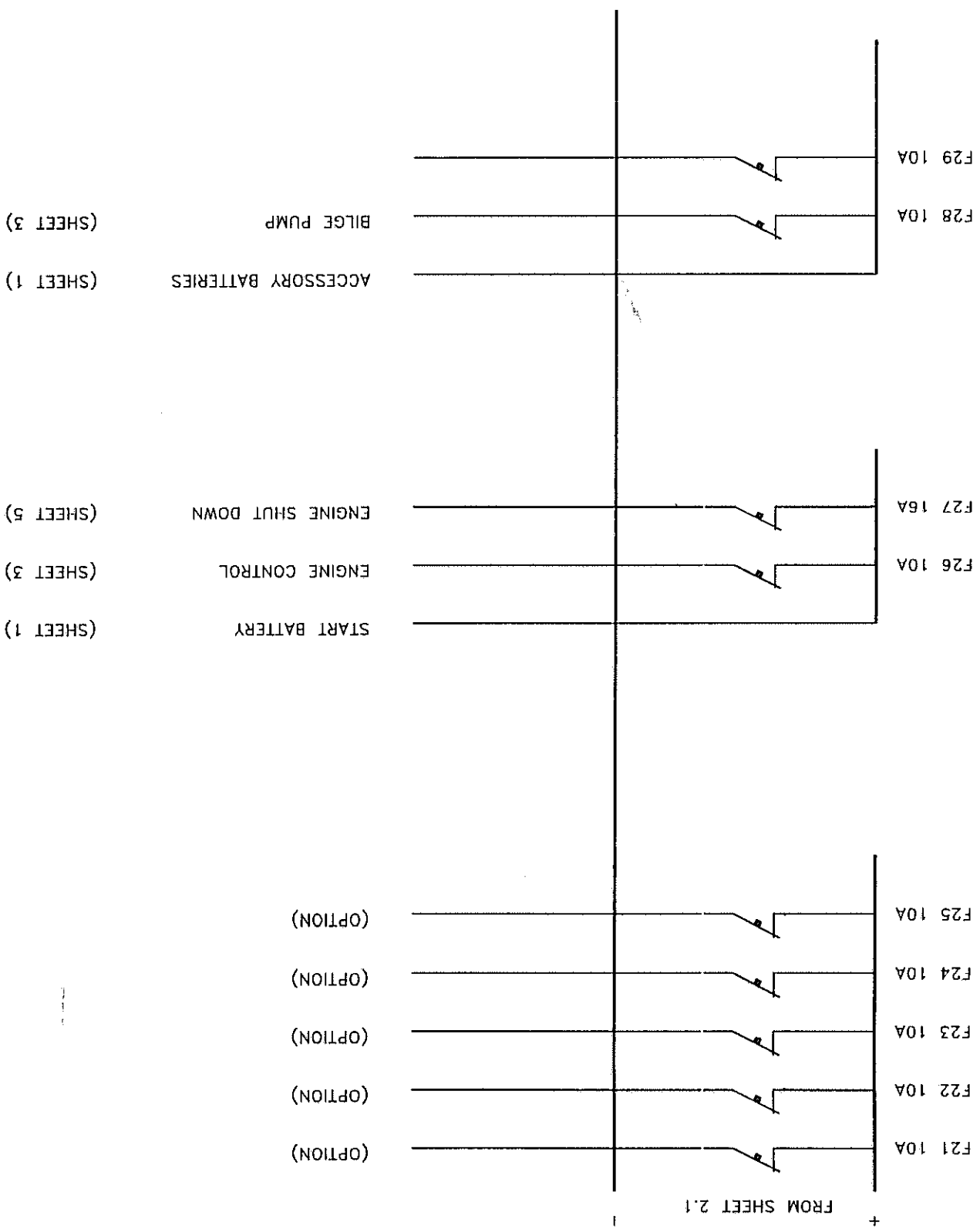

(SHEET 3) BILGE PUMP  
 (SHEET 1) ACCESSORY BATTERIES

(SHEET 5) ENGINE SHUT DOWN  
 (SHEET 3) ENGINE CONTROL  
 (SHEET 1) START BATTERY

(OPTION) F21 10A  
 (OPTION) F22 10A  
 (OPTION) F23 10A  
 (OPTION) F24 10A  
 (OPTION) F25 10A

F29 10A  
 F28 10A  
 F27 16A  
 F26 10A

FROM SHEET 2.1

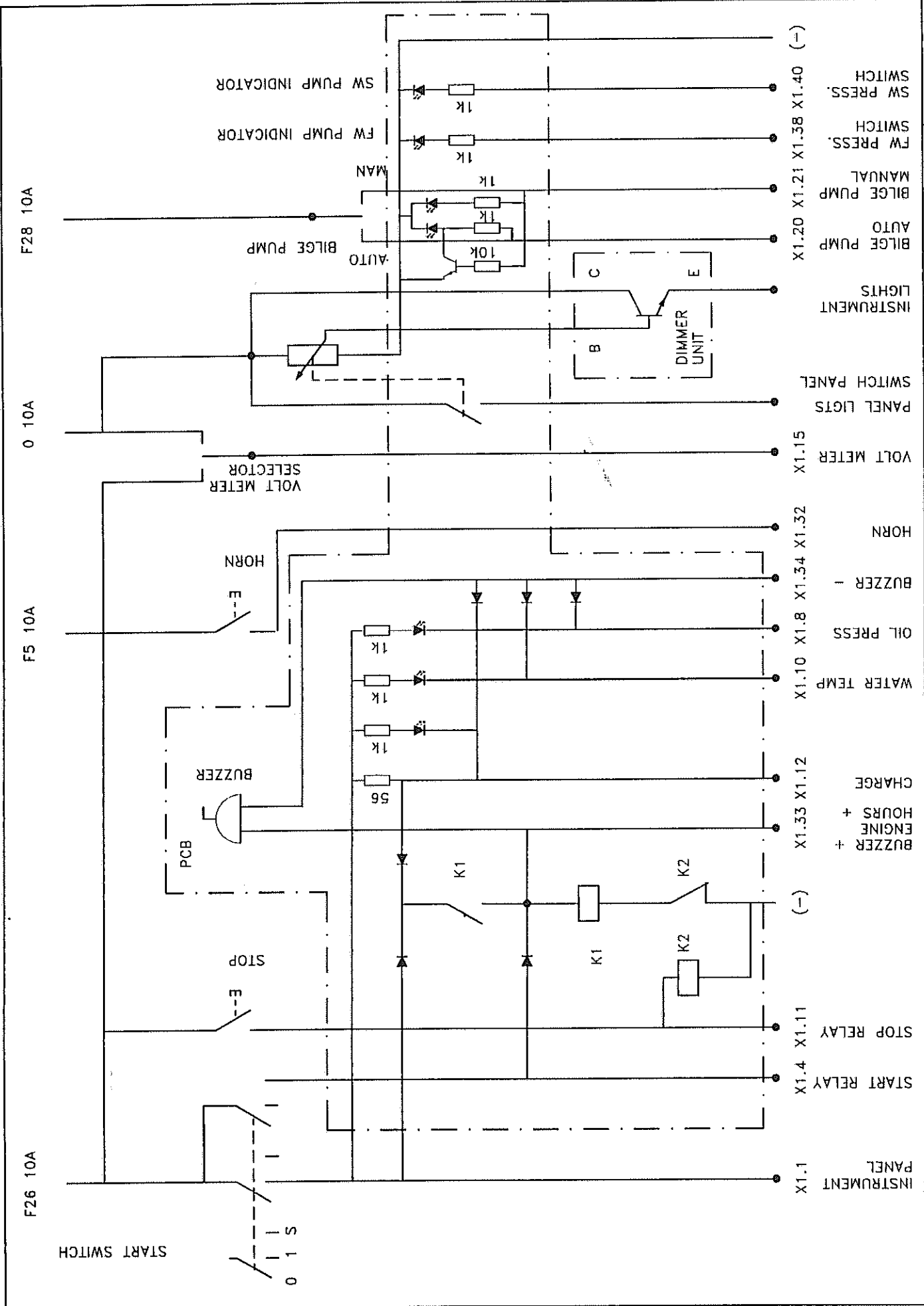

F28 10A

0 10A

F5 10A

F26 10A

START SWITCH

SW PUMP INDICATOR

FW PUMP INDICATOR

BILGE PUMP

VOLT METER SELECTOR

HORN

BUZZER

STOP

MAN

AUTO

PCB

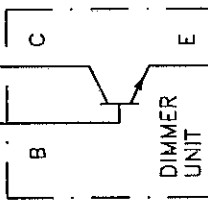

- X1.1 INSTRUMENT PANEL
- X1.4 START RELAY
- X1.11 STOP RELAY
- (-) K1
- X1.33 ENGINE HOURS +
- X1.12 CHARGE
- X1.10 WATER TEMP
- X1.8 OIL PRESS
- X1.34 BUZZER -
- X1.32 HORN
- X1.15 VOLT METER
- SWITCH PANEL
- INSTRUMENT LIGHTS
- BILGE PUMP AUTO
- BILGE PUMP MANUAL
- FW PUMP SWITCH
- SW PUMP SWITCH
- X1.20
- X1.21
- X1.38
- X1.40 (-)

CAD FILE 40032ACP	DRAW JP	DATE 120793	REVISION
		CHECK	DWS. NO.
LAIVASÄHKÖTYÖ OY PO BOX 25 20201 TURKU Phone: +358 21 306200			
CONTROL PANEL			

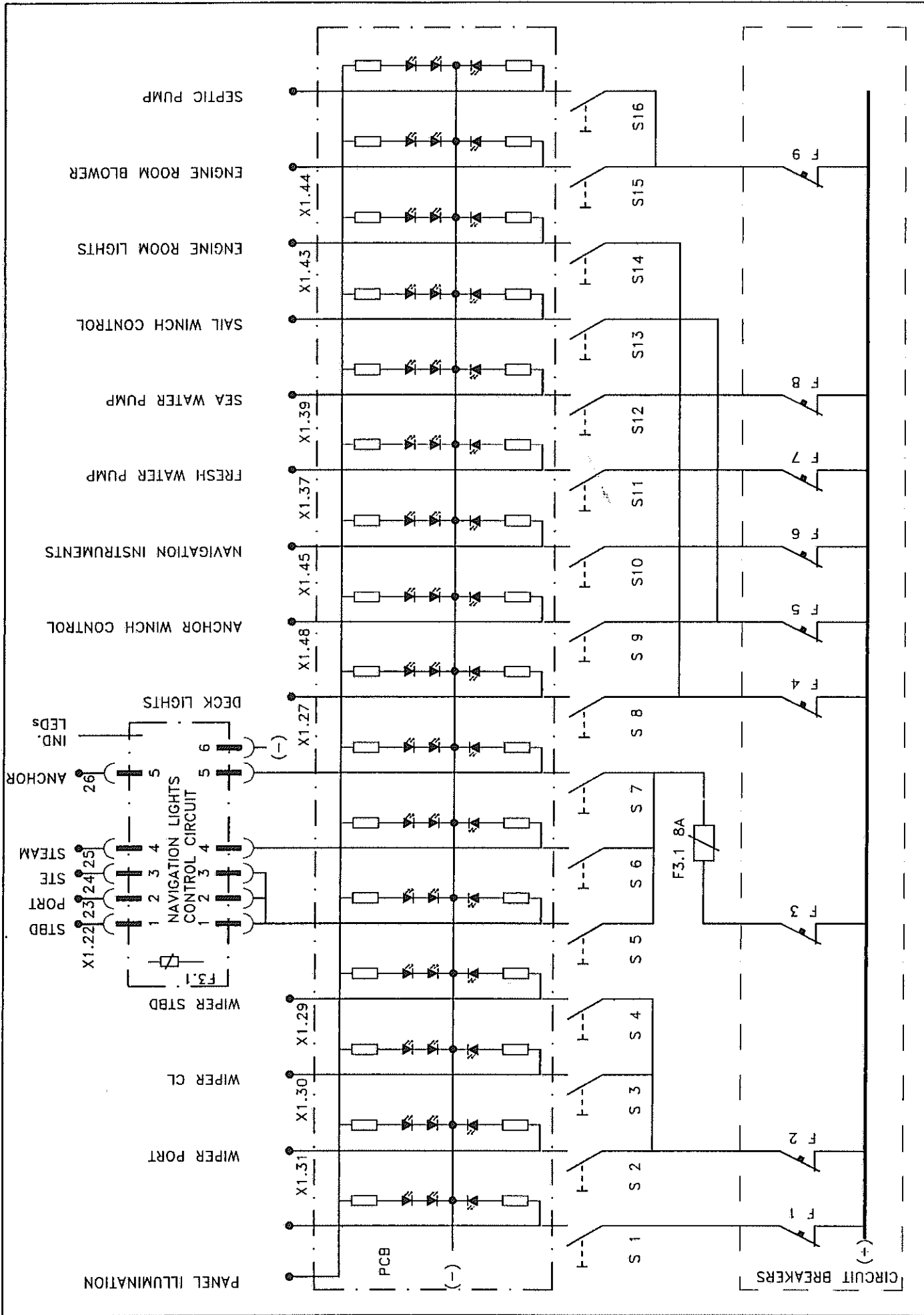

CAD FILE 32031ASW	DRAW JP	SHEET REVISION	
		DATE 060793	DWG. NO.
SCALE	CHECK	SILTALA YACHTS NAUTIC	
LAIVASAHKOTOYO OY PO BOX 25 20201 TURKU Phone: +358 21 306200		SWITCH PANEL	
			

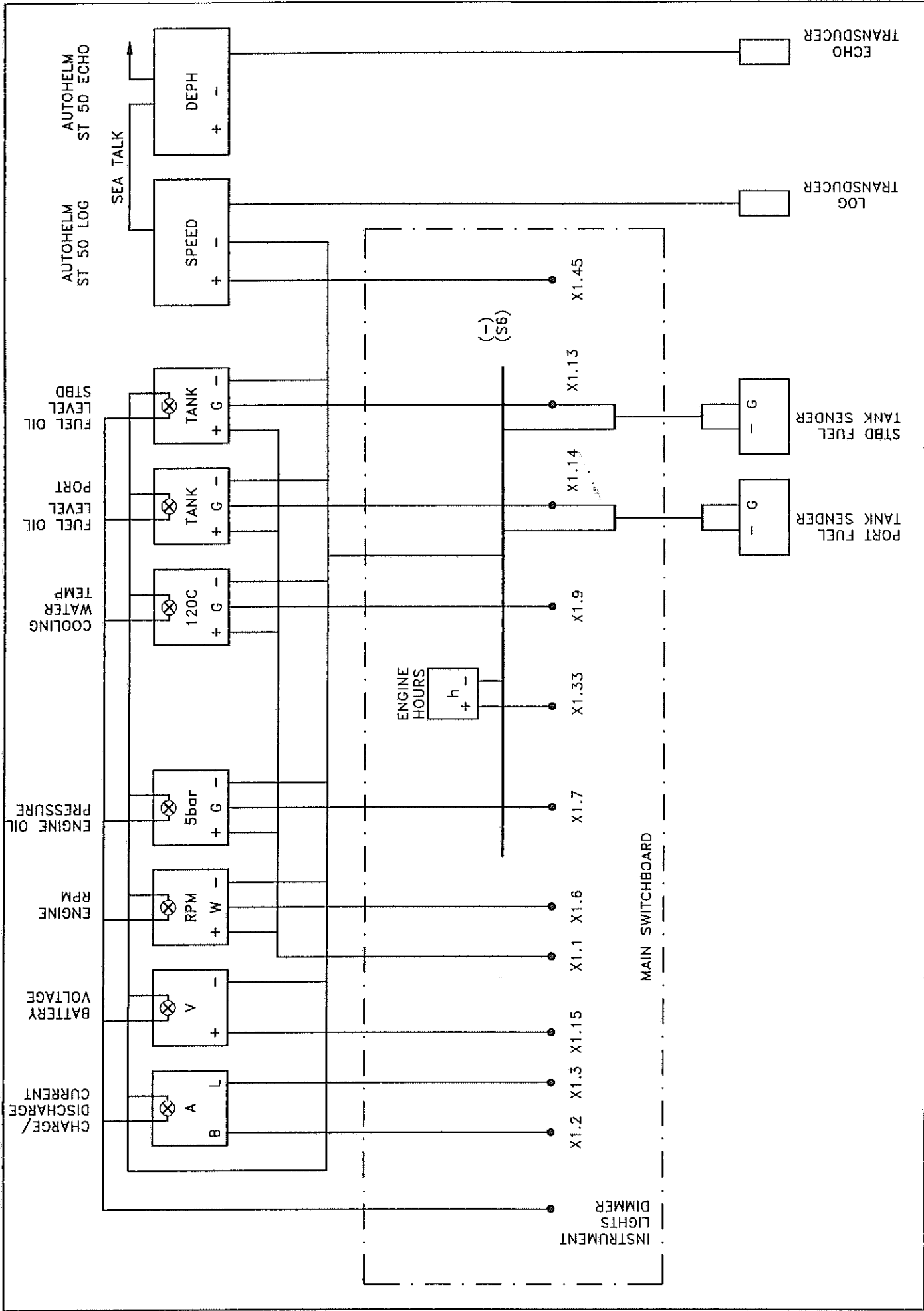

CAD FILE	3504AIP	DRAW	J.P.	SHEET	4( )	REVISION
SCALE		DATE	100593	YANMAR		
		CHECK		INSTRUMENT PANEL		
				<b>SILTALA YACHTS</b> <b>NAUTICAT</b>		
LAIVASAHKOTOYO OY PO BOX 25 20201 TURKU Phone: +358 21 306200						

FRESH WATER LEVEL

AUTOPILOT

AUTOHELM SEA TALK INSTRUMENTS

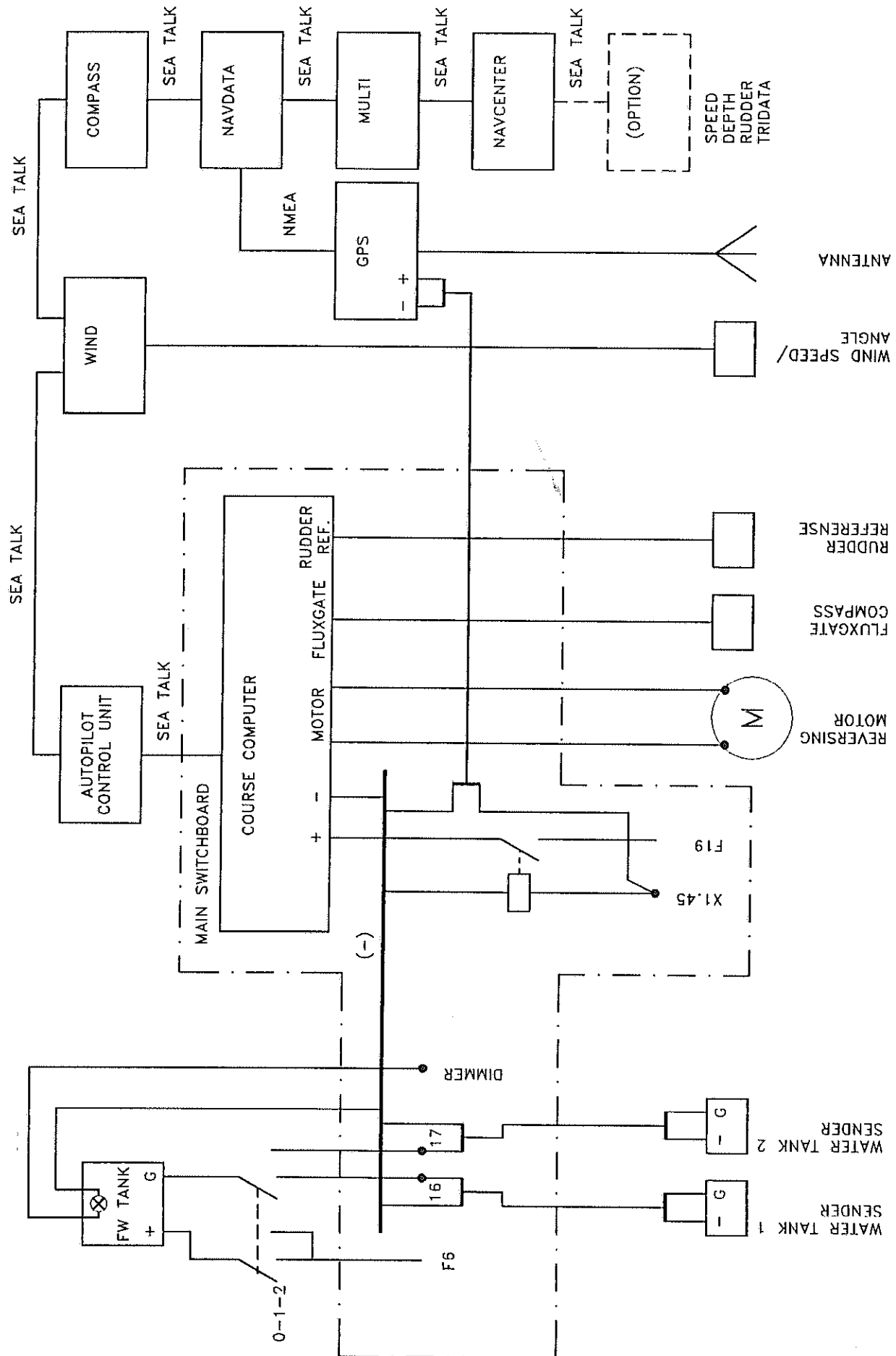

CAD FILE	400411NS	DRAW	JP	SHEET	REVISION
SCALE		DATE	191193	DWG. NO.	
		CHECK			
LAIVASÄHKÖTYÖ OY			SILTALA YACHTS		
PO BOX 25 20201 TURKU			OPTIONAL INSTRUMENTS		
Phone: +358 21 306200			NAUTICAT		



RPM METER X1.6  
 START SWITCH X1.1  
 + BAR (R1)  
 CHARGE INDICATOR DISCONNECT RELAY X1.12  
 MAIN SWITCH  
 STOP BUTON X1.11  
 F 27 16A  
 START SWITCH X1.4  
 ENGINE OIL PRESSURE GAUGE X1.7  
 ENGINE OIL PRESSURE ALARM X1.8  
 WATER TEMPERATURE GAUGE X1.9  
 WATER TEMPERATURE ALARM X1.10

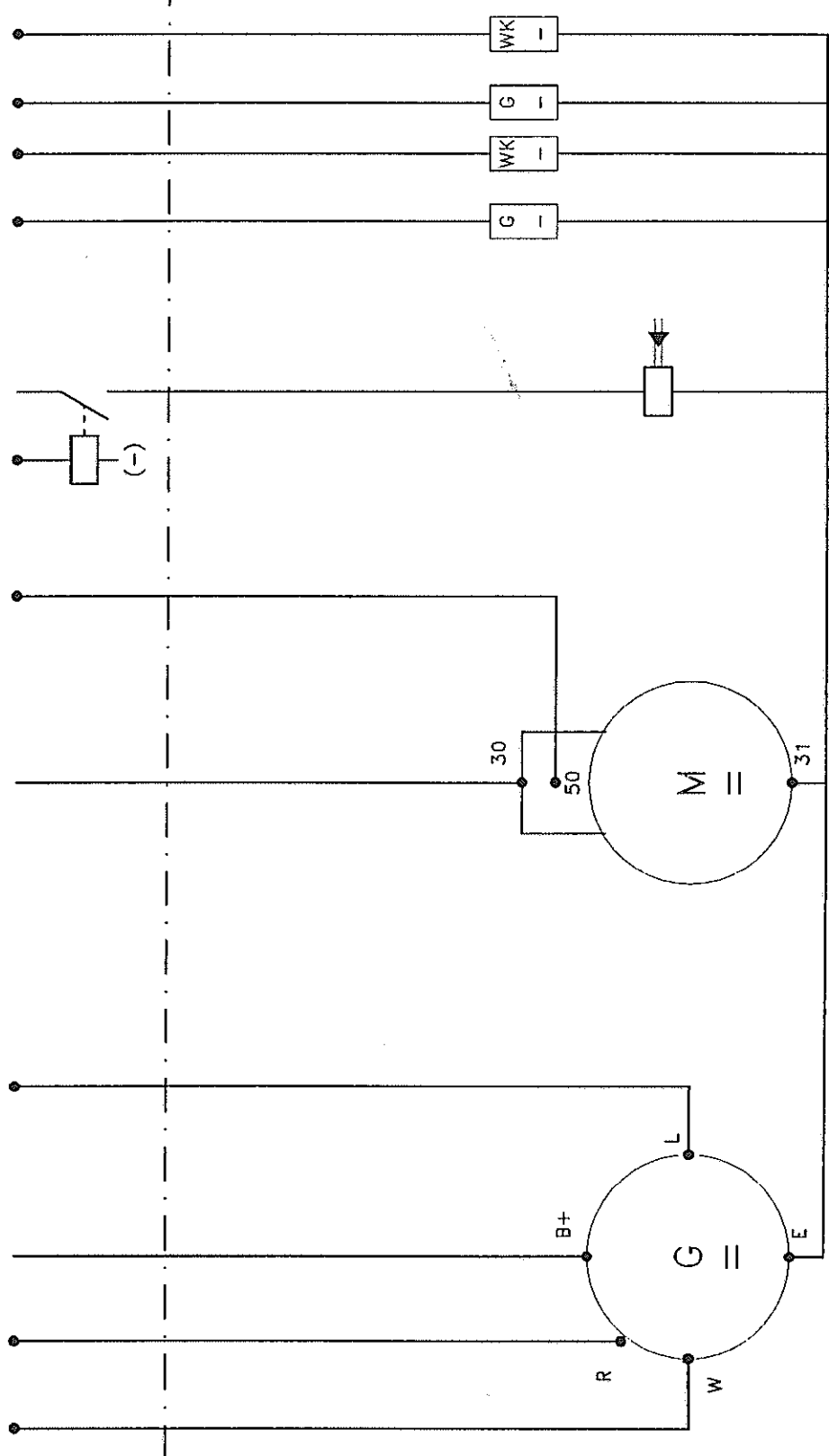

ALTERNATOR  
 START MOTOR  
 SHUT DOWN SOLENOID  
 OIL PRESS SENDER  
 WATER TEMP SENDER

CAD FILE	3205AENG	DRAW	JP	SHEET	REVISION
SCALE		DATE	090793	DWG. NO.	
		CHECK			
LAIVASAHKOTOYO OY			SILTALA YACHTS		
PO BOX 25 20201 TURKU			YANMAR		
Phone: +358 21 306200			MAIN ENGINE		
NAUTICAL					

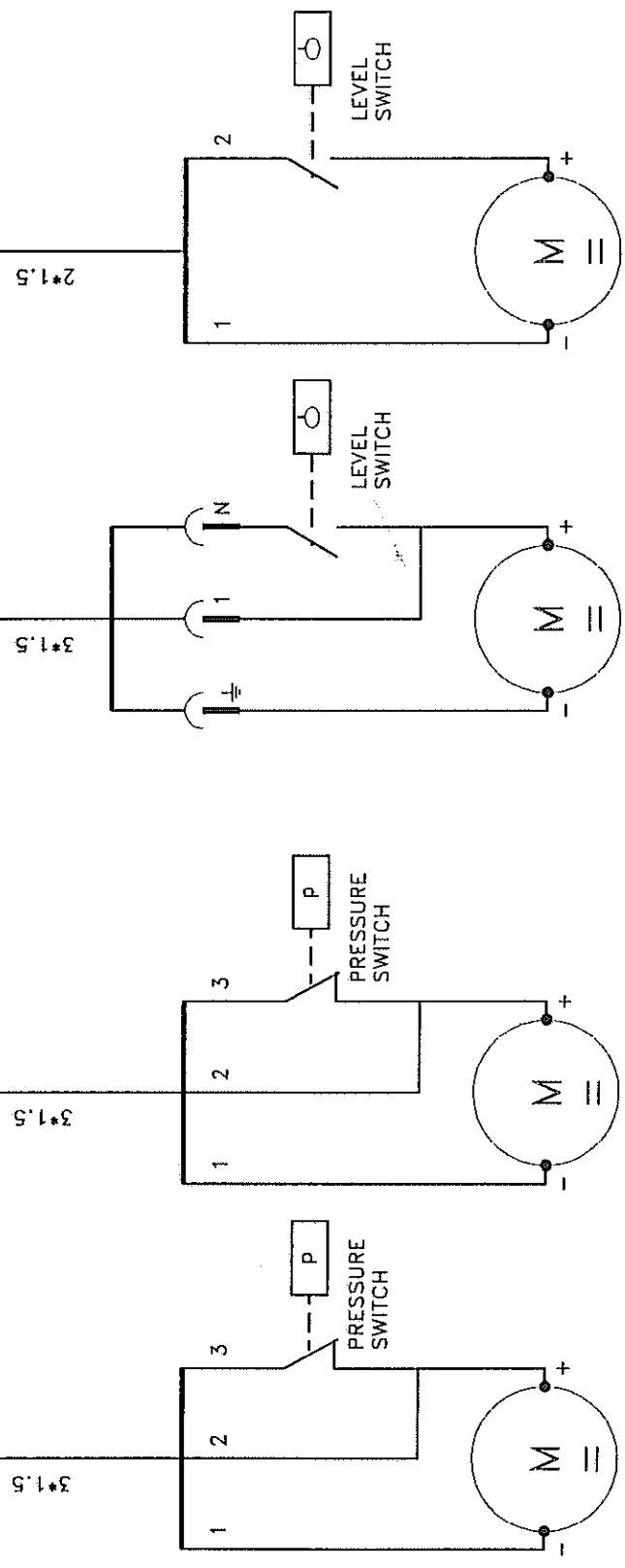
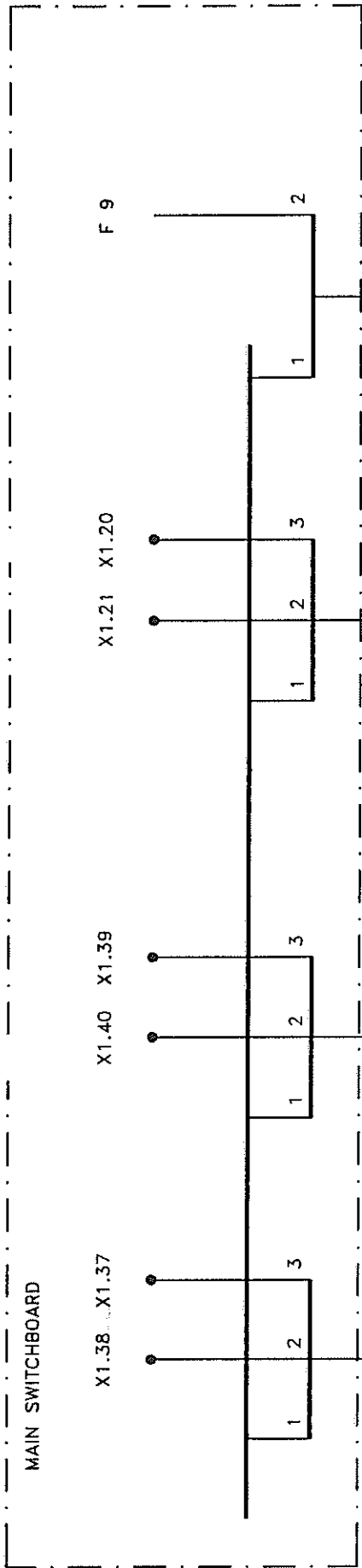

FRESH WATER PUMP

SEA WATER PUMP

BILGE PUMP

SHOWER DRAIN PUMP

(OPTION)

(OPTION)

CAD FILE

PUMP

DRAW

JP

SCALE

DATE

250893

CHECK



LAIVASAHKOTYO OY

PO BOX 25 20201 TURKU

Phone: +358 21 306200

SILTALA YACHTS

NAUTICAT

PUMPS

SHEET

REVISION

DWG. NO.

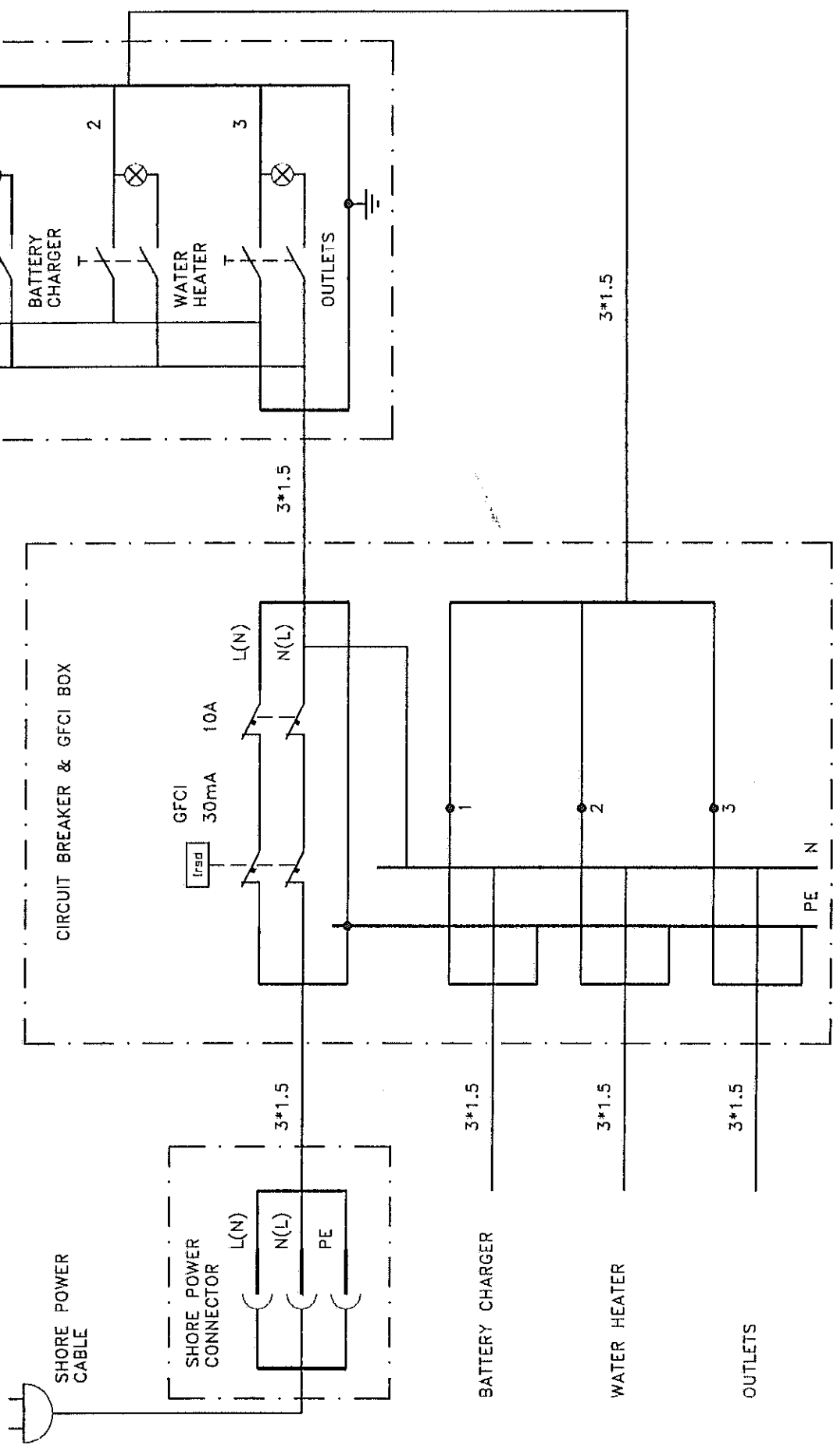

CAD FILE	SHORE	DRAW	JP	SHEET	REVISION	B
	SCALE		DATE		DWG. NO.	
		LAIVASAHOYO OY		SILTALA YACHTS		
		PO BOX 25 20201 TURKU		NAUTICAT		
		Phone: +358 21 306200		SHORE POWER SYSTEM		

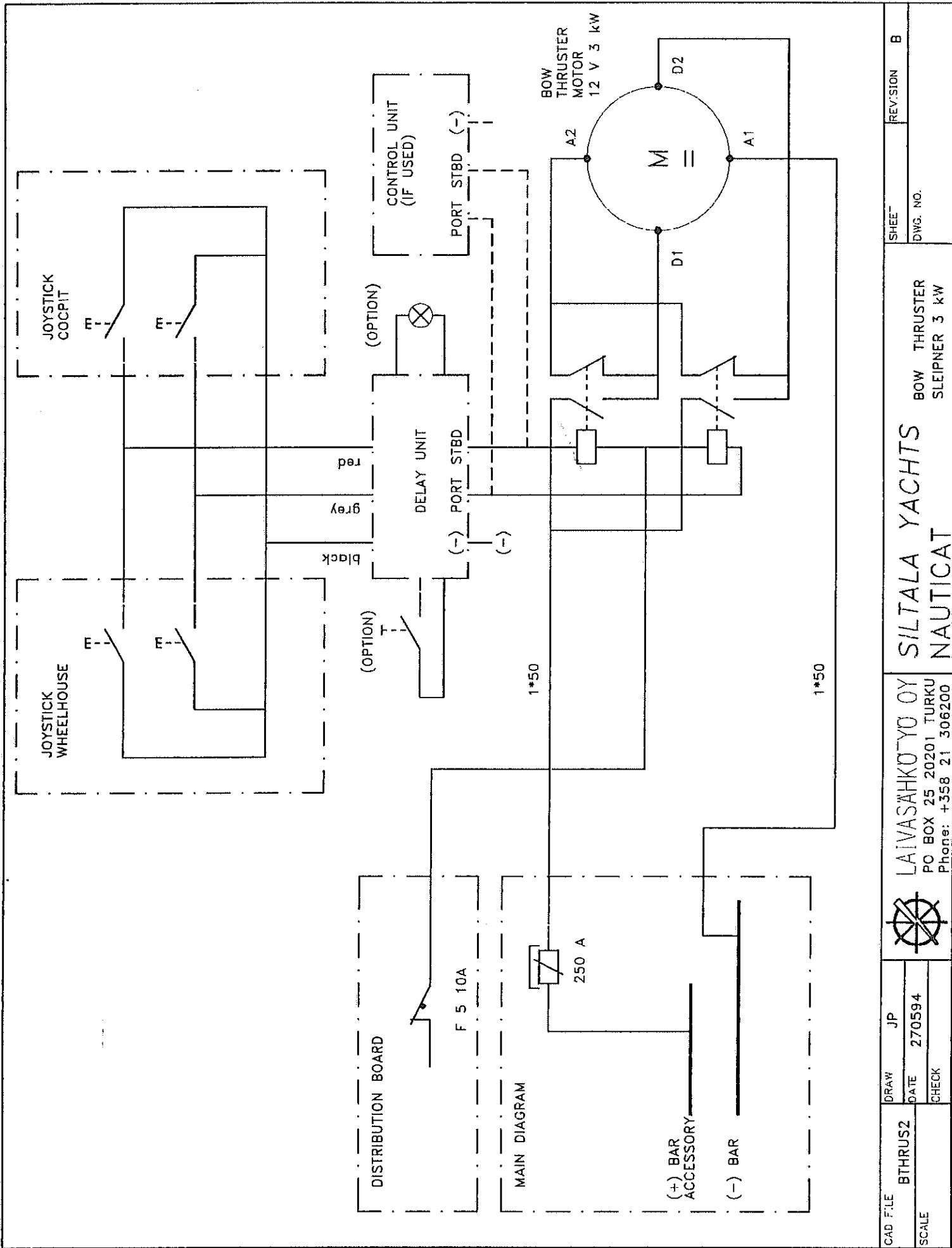

CAD FILE	BTHRUS2	DRAW	JP	SHEET	REVISION	B
SCALE		DATE	270594	DWG. NO.		
		CHECK				
				<b>SILTALA YACHTS</b> BOW THRUSTER SLEIPNER 3 kW <b>NAUTICAT</b>		
LAIVASÄHKÖTYÖ OY PO BOX 25 20201 TURKU Phone: +358 21 306200						

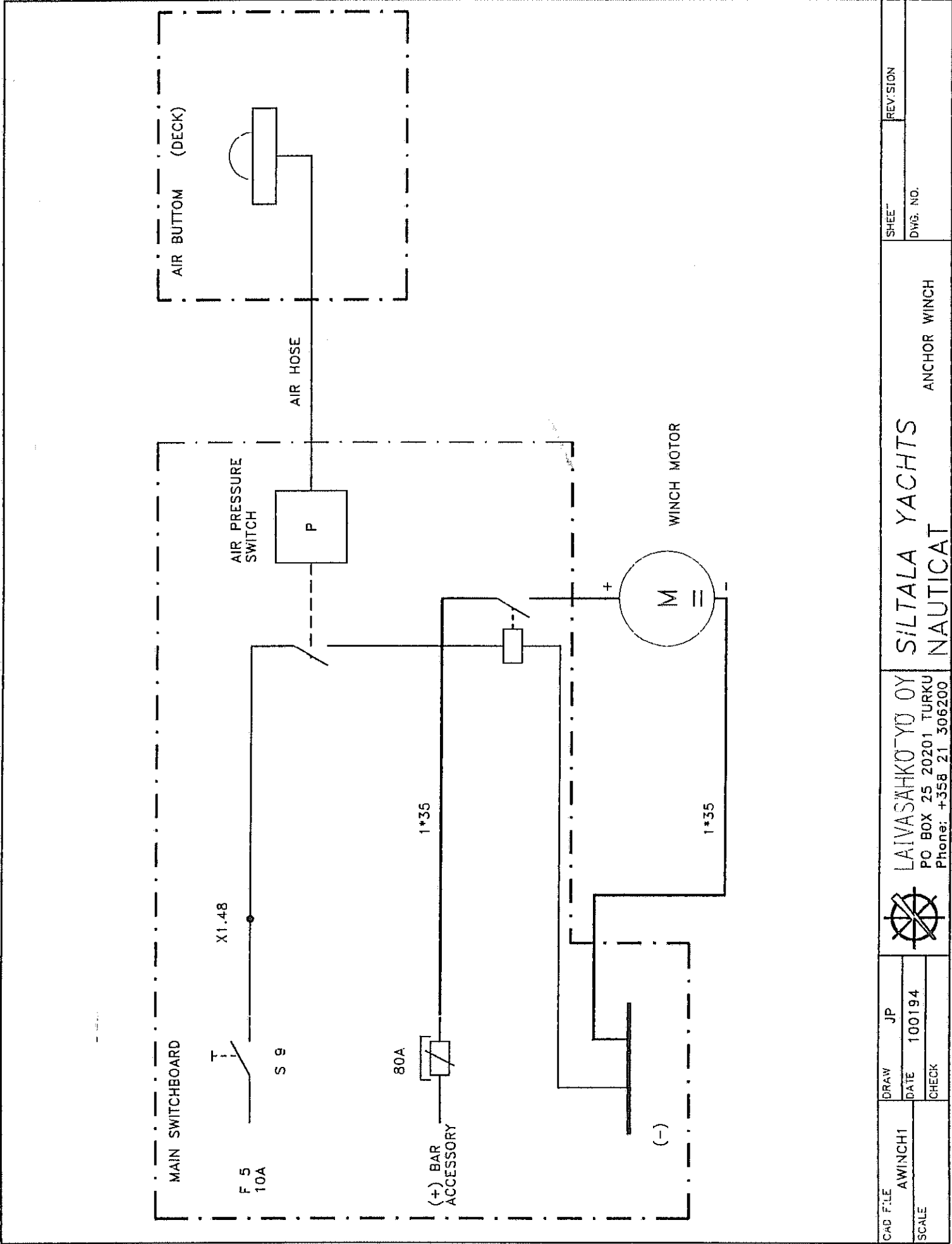

CAB FILE	AWINCH1	DRAW	JP	SILTALA YACHTS NAUTICAT	SHEET	REVISION
	SCALE	DATE	100194		DWG. NO.	
				LAIVASAHKO OY	ANCHOR WINCH	
				PO BOX 25 20201 TURKU		
				Phone: +358 21 306200		