

44/733

E9	FIRE FIGHTING INSTALLATION DWG. NO. 44.000.E9
E8	GENERATOR DWG. NO. 44.000.E8
E7	AC-PANEL DWG. NO. 44.0.E7
E6	BATTERY CHARGER DWG. NO. 44.000.E6
E5	COOLING SYSTEM DWG. NO. 44.00.E5
E4	HEATING SYSTEM DWG. NO. 44.000.E4
E3	STEER WANCH DWG. NO. 44.000.E3
E2	ANCHOR WINCH DWG. NO. 44.000.E2
E1	BOW THRUSTER DWG. NO. 44.000.E1

E = EXTRA EQUIPMENTS

S7	BILGE PUMP DWG. NO. 44.000.S7
S6	SALON SWITCHBOARD DWG. NO. 44.100.S6 SH. 1-2
S5	INSTRUMENT PANEL DWG. NO. 44.000.S5
S4	CIRCUIT BREAKER AND CONTROL PANEL DWG. NO. 44.100.S4 SH. 1-2
S3	ENGINE ELECTRICAL EQUIP- MENTS DWG. NO. 44.100.S3
S2	MAIN SWITCH DWG. NO. 44.000.S2
S1	BATTERIES DWG. NO. 44.00.S1

S = STANDARD EQUIPMENTS

NO. MUUTOS	REVISION	TEXTI	HYVAKES	Pvm.
SUUNN. ELÄKÖN JÄLJ.	TARK.	REVISION	HYVAKES	Pvm.
Pvm. 11.1.1984	Pvm.	Pvm.	Pvm.	Pvm.

YACHT MODULE OY

NIMI: SILTALA YACHTS OY, NAUTICAT 44
ELECTRICAL SYSTEM, BLOCK DIAGRAM

LEHTI SHEET () NO. MUUTOS REVISION
No. 44 DRAWING A1

A1

11

12

13

14

15

16

17

A

B

C

D

E

F

G

H

J

K

L

M

N

P

R

S

T

U

V

A

B

C

D

E

F

G

H

J

K

L

M

N

P

R

S

T

U

V

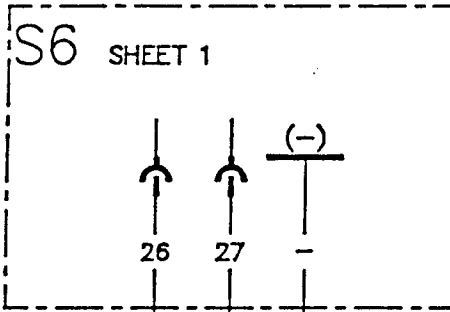

3x2,5

TERMINAL BLOCK NEAR PUMP

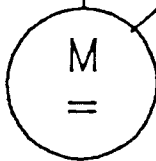
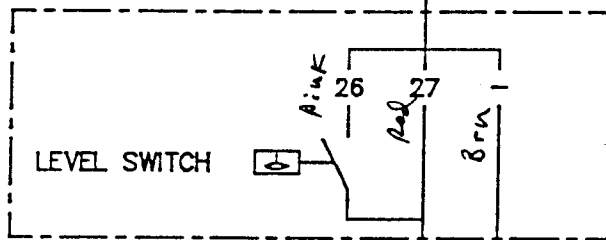

BILGE PUMP MOTOR

S7

YACHT

MODULE OY

NIMI SILTALA YACHTS OY, NAUTICAT 44
ELECTRICAL SYSTEM, BILGE PUMP

NAME

LEHTI	SHEET	MUUTOS	REVISION
No.	()	No.	

No.	MUUTOS	REVISION	TEKI	Pvm.
SUUNN.	ELCAD OY	JÄLJ.	TARK.	HYVÄKS.
Pvm.	11.7.1984	Pvm.	Pvm.	Pvm.

PIIRUSTUS	DRAWING
No.	44.000.S7

V U T S R P N M L K J I H G F E D C B A

No. MUOTOS
SUUNN. ELEC. OY JALU
Pvm. 28.1.1984 Pvm.
REVISION TEK. HYVANS.
Pvm. Pvm.

YACHT ELECTRICAL SYSTEM MODULE 07

NIMI SILTALA YACHTS OY, NAUTICAT 44
ELECTRICAL SYSTEM,
NAME 220V 50HZ GENERATOR AND SHORE POWER PANEL

LEHTI SHEET MUOTOS REVISION
No. () NO.
PIRUSTUS DRAWING
No. 44.103.E7

V U T S R P N M L K J I H G F E D C B A

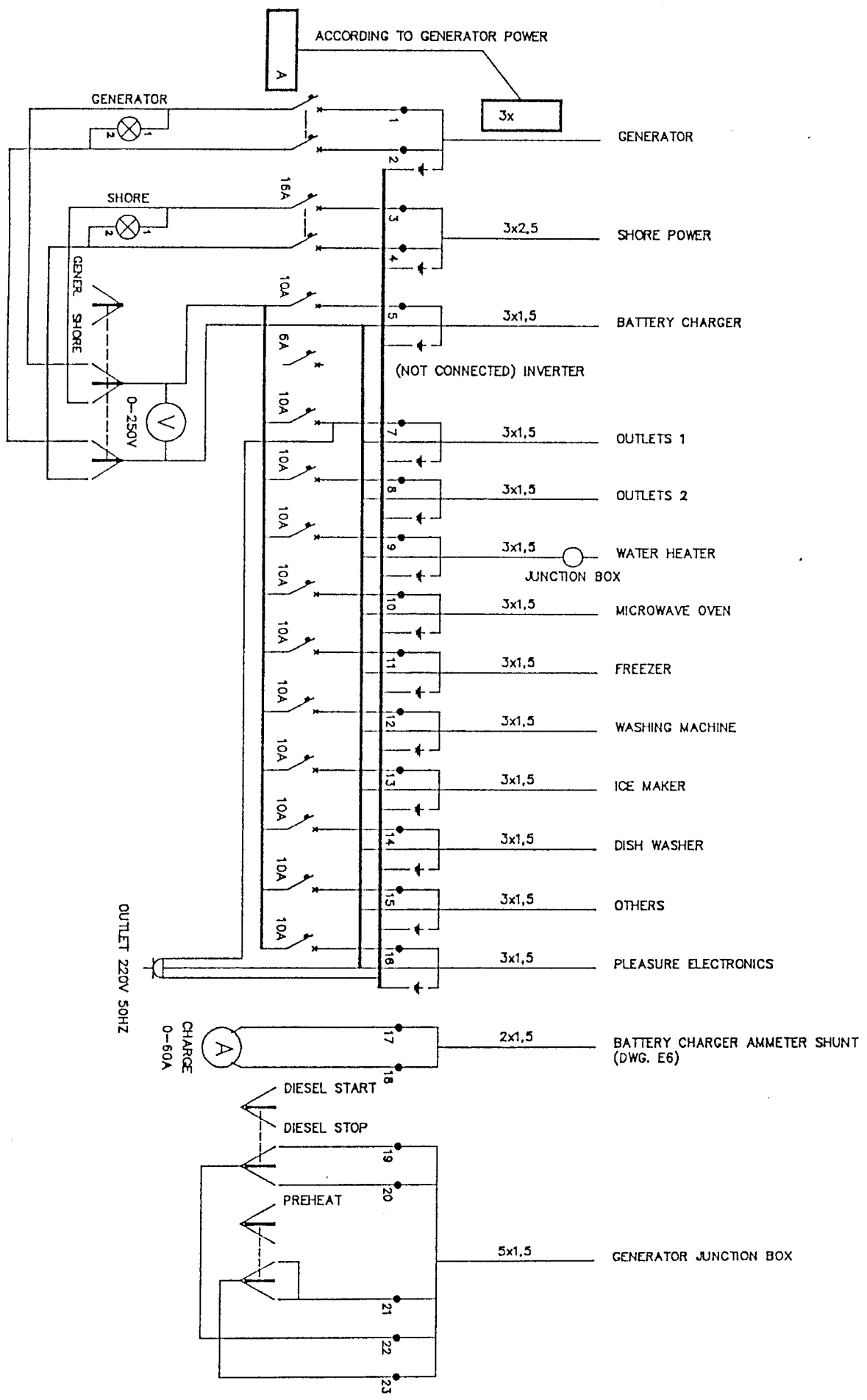

E7

11

12

13

14

15

16

17

A

B

C

D

E

F

G

H

J

K

L

M

N

P

R

S

T

U

V

A

B

C

D

E

F

G

H

J

K

L

M

P

R

R

S

T

U

V

12V 90Ah

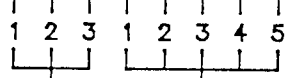
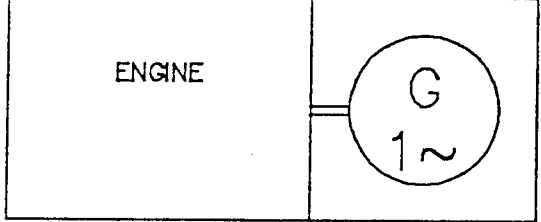
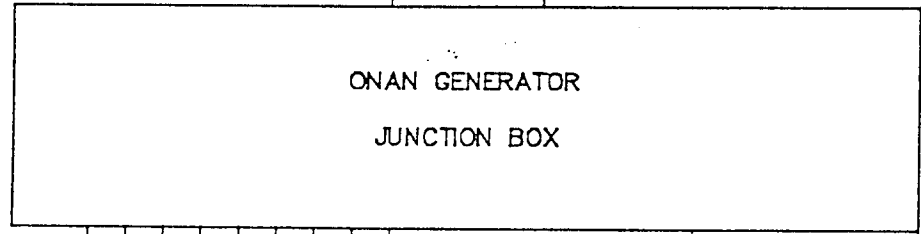
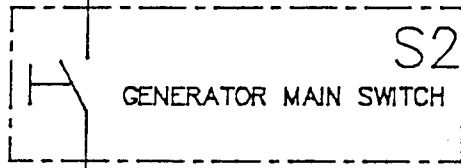
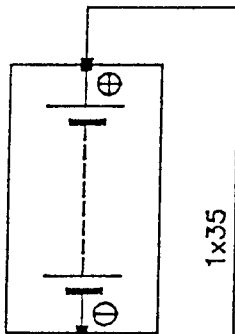

ACCORDING TO GENERATOR POWER



5x1,5

TO AC PANEL

GENERATOR MAIN DATA

VOLTAGE:	<u>220</u> V
FREQUENCY:	<u>50</u> HZ
POWER:	<u>6</u> kW

E8

YACHT

 MODULE OY

NIMI SILTALA YACHTS OY, NAUTICAT 44
 ELECTRICAL SYSTEM, GENERATOR

NAME

LEHTI	SHEET	MUUTOS	REVISION
No.	()	No.	

No. MUUTOS	REVISION	TEKI	Pvm.
SUUNN-ELCADO OY Pvm. 11.7.1984	JÄLJ. Pvm.	TARK. Pvm.	HYVÄKS. Pvm.

PIIRUSTUS DRAWING
 No. 44.000.E8

11

12

13

14

15

16

17

A

B

C

D

E

F

G

H

J

K

L

M

N

P

R

S

A

B

C

D

E

F

G

H

J

K

L

M

N

P

R

S

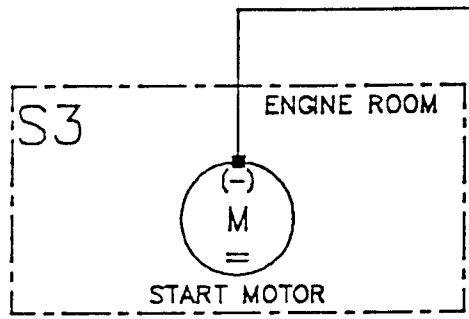
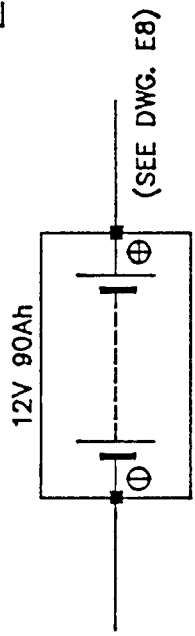
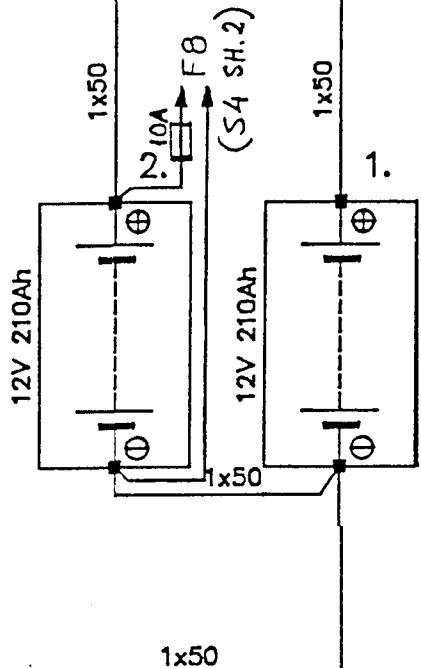
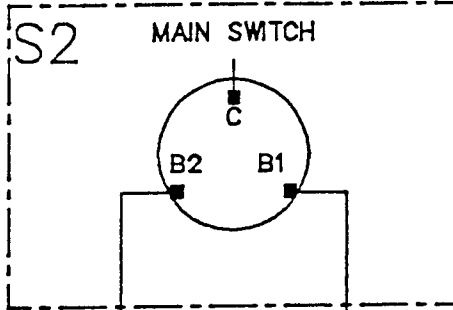

S1

YACHT
 [] [] [] []
 MODULE OY

NIMI SILTALA YACHTS OY, NAUTICAT 44
 ELECTRICAL SYSTEM, BATTERIES

NAME

LEHTI	SHEET	MUUTOS	REVISION
No.	()	No.	

No.	MUUTOS	REVISION	TEKI	Pvm.
SUUNN.	ELEKAS OY	JÄLJ.	TARK.	HYVÄKS.
Pvm.	11.7.1984	Pvm.	Pvm.	Pvm.

PIIRUSTUS DRAWING
 No. 44.000.S1

11

12

13

14

15

16

17

A

B

C

D

E

F

G

H

J

K

L

M

N

P

R

S

T

U

V

A

B

C

D

E

F

G

H

J

K

L

M

P

R

S

T

U

V

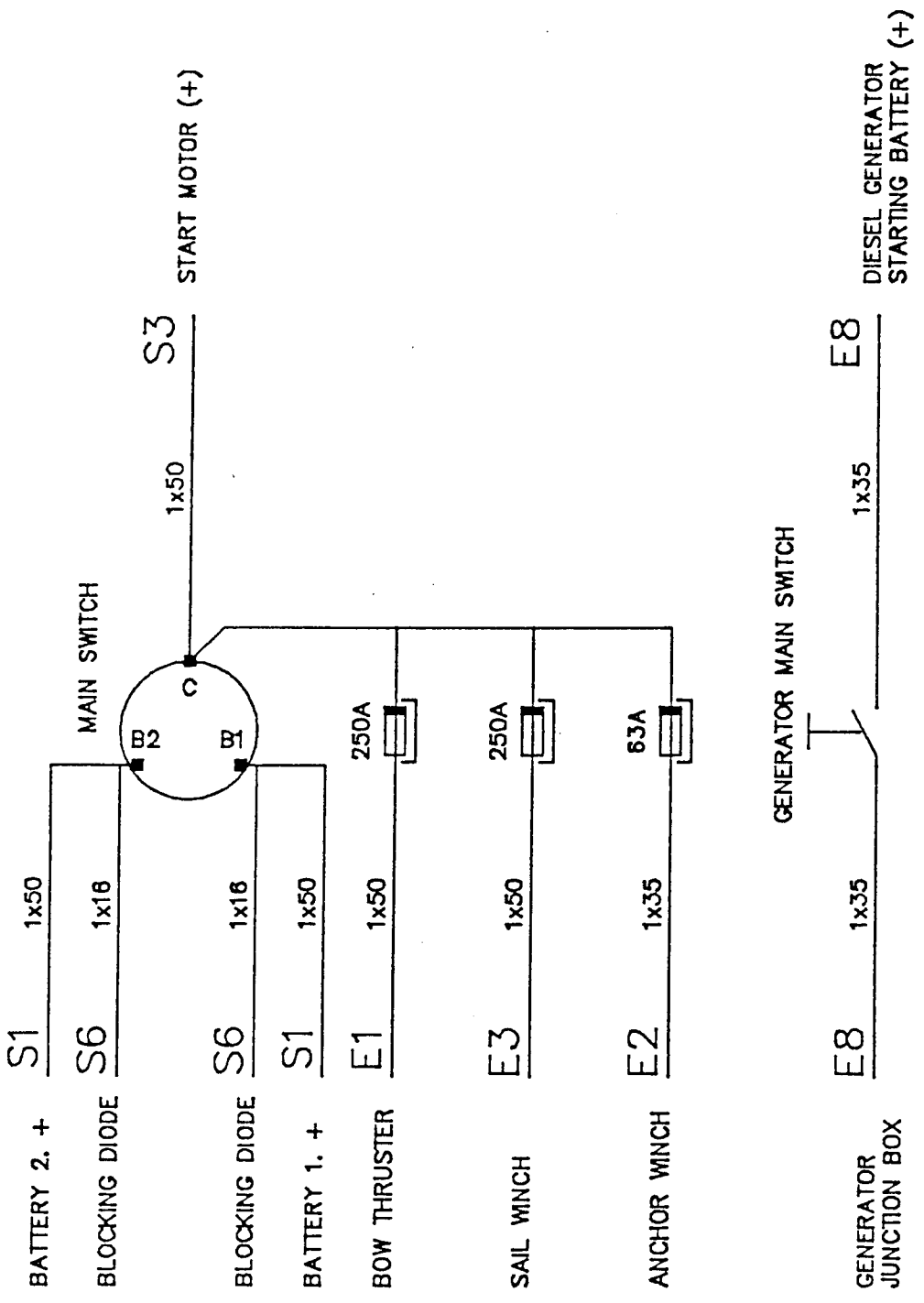

S2

YACHT

MODULE OY

NIMI SILTALA YACHTS OY, NAUTICAT 44
ELECTRICAL SYSTEM, MAIN SWITCH

NAME

LEHTI	SHEET	MUUTOS	REVISION
No.	()	No.	

No.	MUUTOS	REVISION	TEKI	Pvm.
SUUNN.	ELLÄÖÖY	JÄLJ.	TARK.	HYVÄKS.
Pvm.	11.7.1984	Pvm.	Pvm.	Pvm.

PIIRUSTUS DRAWING
No. 44.000.S2

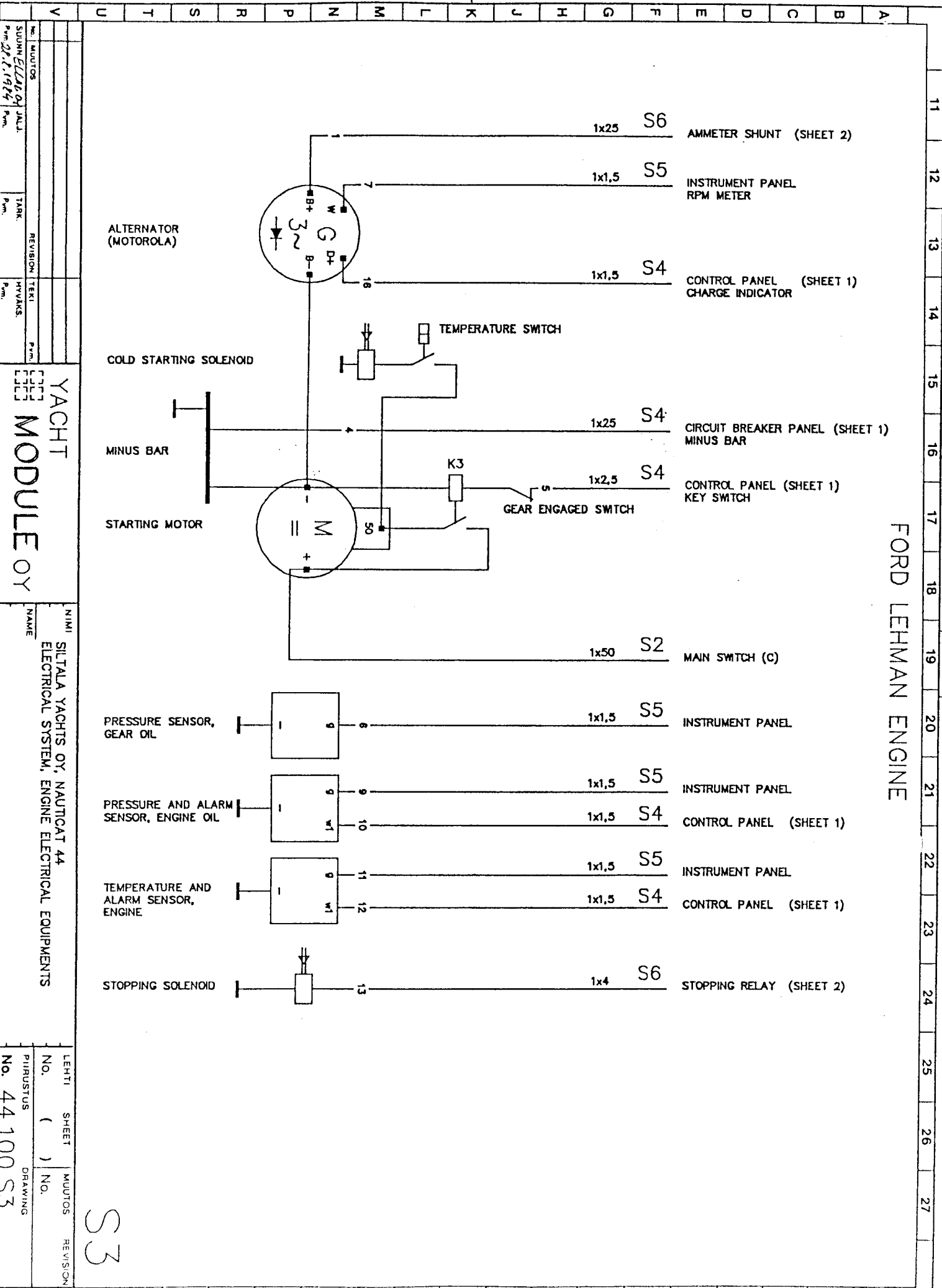

FORD LEHMAN ENGINE

YACHT	YACHT	YACHT	YACHT
MODULE OY	MODULE OY	MODULE OY	MODULE OY
NAME	NAME	NAME	NAME
SILTALA YACHTS OY, NAUTICAT 44	SILTALA YACHTS OY, NAUTICAT 44	SILTALA YACHTS OY, NAUTICAT 44	SILTALA YACHTS OY, NAUTICAT 44
ELECTRICAL SYSTEM, ENGINE ELECTRICAL EQUIPMENTS	ELECTRICAL SYSTEM, ENGINE ELECTRICAL EQUIPMENTS	ELECTRICAL SYSTEM, ENGINE ELECTRICAL EQUIPMENTS	ELECTRICAL SYSTEM, ENGINE ELECTRICAL EQUIPMENTS
PIIRUSTUS	PIIRUSTUS	PIIRUSTUS	PIIRUSTUS
No. 44.100.S3	No. 44.100.S3	No. 44.100.S3	No. 44.100.S3
LEHTI	LEHTI	LEHTI	LEHTI
()	()	()	()
SHEET	SHEET	SHEET	SHEET
MUUTOS	MUUTOS	MUUTOS	MUUTOS
REVISION	REVISION	REVISION	REVISION
No. 44.100.S3	No. 44.100.S3	No. 44.100.S3	No. 44.100.S3
PIIRUSTUS	PIIRUSTUS	PIIRUSTUS	PIIRUSTUS
DRAWING	DRAWING	DRAWING	DRAWING
No. 44.100.S3	No. 44.100.S3	No. 44.100.S3	No. 44.100.S3
LEHTI	LEHTI	LEHTI	LEHTI
()	()	()	()
SHEET	SHEET	SHEET	SHEET
MUUTOS	MUUTOS	MUUTOS	MUUTOS
REVISION	REVISION	REVISION	REVISION
No. 44.100.S3	No. 44.100.S3	No. 44.100.S3	No. 44.100.S3
PIIRUSTUS	PIIRUSTUS	PIIRUSTUS	PIIRUSTUS
DRAWING	DRAWING	DRAWING	DRAWING
No. 44.100.S3	No. 44.100.S3	No. 44.100.S3	No. 44.100.S3

S3

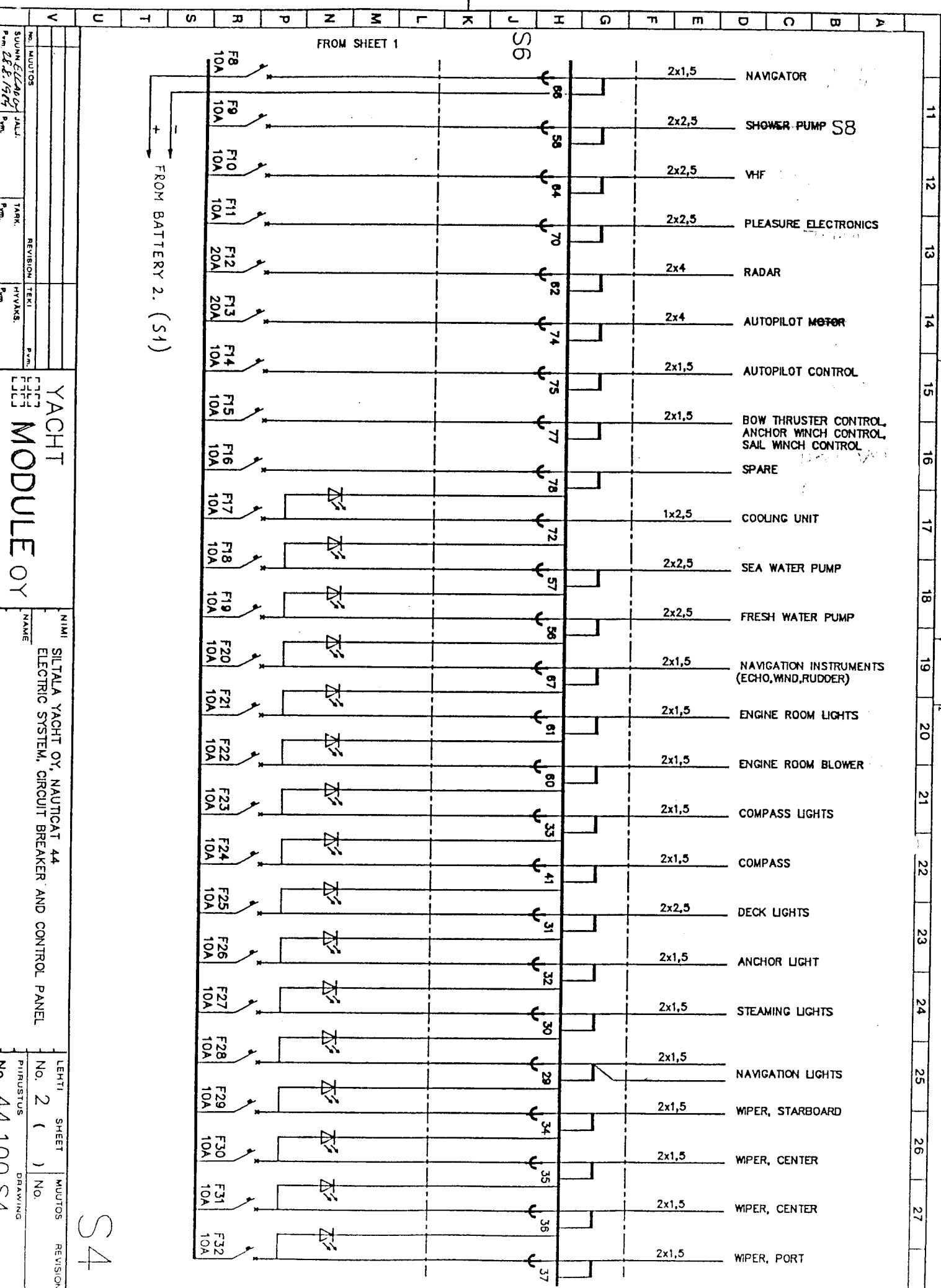

NO.	MUUTOS
NO.	REVISION
NO.	TEKNI
NO.	HYVAKS.
NO.	P.

YACHT
MODULE OY

NAME	NIMI
NAME	SILTALA YACHT OY, NAUTICAT 44
NAME	ELECTRIC SYSTEM, CIRCUIT BREAKER AND CONTROL PANEL
LEHTI SHEET	NO. 2 ()
MUUTOS	NO.
REVISION	NO.

S4

V
U
T
S
R
P
N
M
L
K
J
H
G
F
E
D
C
B
A

11
12
13
14
15
16
17
18
19
20
21
22
23
24
25
26
27

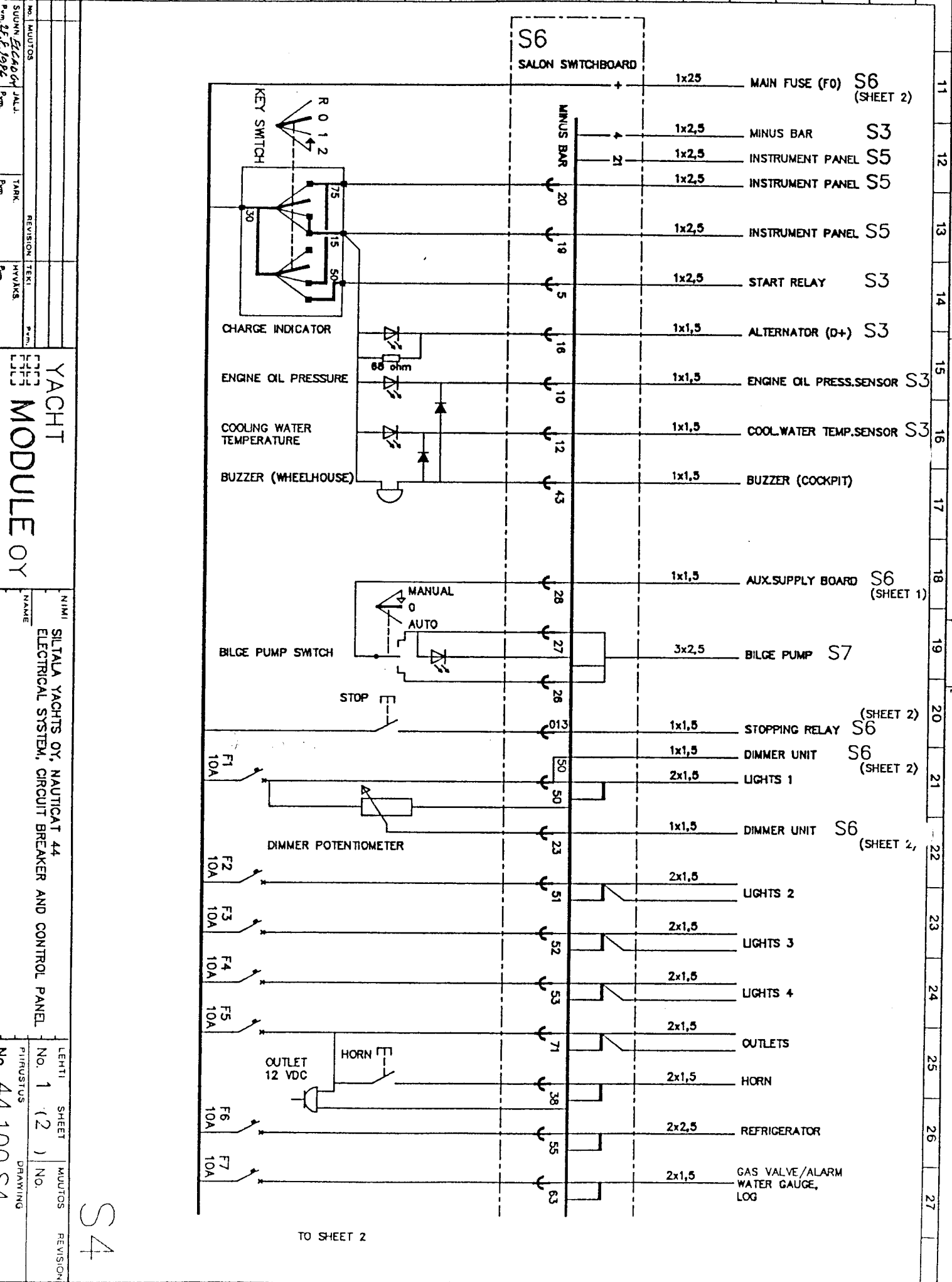

Terminal	Component	Quantity	Sheet Reference
+	MAIN FUSE (F0)	1x25	S6 (SHEET 2)
MINUS BAR	MINUS BAR	1x2,5	S3
21	INSTRUMENT PANEL	1x2,5	S5
20	INSTRUMENT PANEL	1x2,5	S5
19	INSTRUMENT PANEL	1x2,5	S5
5	START RELAY	1x2,5	S3
16	ALTERNATOR (D+)	1x1,5	S3
10	ENGINE OIL PRESS.SENSOR	1x1,5	S3
12	COOL.WATER TEMP.SENSOR	1x1,5	S3
43	BUZZER (COCKPIT)	1x1,5	
28	AUX.SUPPLY BOARD	1x1,5	S6 (SHEET 1)
27	BILGE PUMP	3x2,5	S7
28	STOPPING RELAY	1x1,5	S6 (SHEET 2)
50	DIMMER UNIT	1x1,5	S6 (SHEET 2)
50	LIGHTS 1	2x1,5	S6 (SHEET 2)
23	DIMMER UNIT	1x1,5	S6 (SHEET 2)
51	LIGHTS 2	2x1,5	
52	LIGHTS 3	2x1,5	
53	LIGHTS 4	2x1,5	
71	OUTLETS	2x1,5	
38	HORN	2x1,5	
55	REFRIGERATOR	2x2,5	
63	GAS VALVE/ALARM WATER GAUGE, LOG	2x1,5	

YACHT
MODULE 0Y

SILTALA YACHTS OY, NAUTICAT 44
ELECTRICAL SYSTEM, CIRCUIT BREAKER AND CONTROL PANEL

TO SHEET 2

S4

REVISION

NO. MAUTOS
SUUNN. EICÄÖN
Pvm. 25.11.1984

JALLI
TARK.
REVISIONI
HYVÄK.
Pvm.

YACHT
MODULE 0Y

NAME

LEHTI SHEET MAUTOS REVISION
No. 1 (2) No.
P.IINUSTUS
No. 44 100 CA
DRAWING

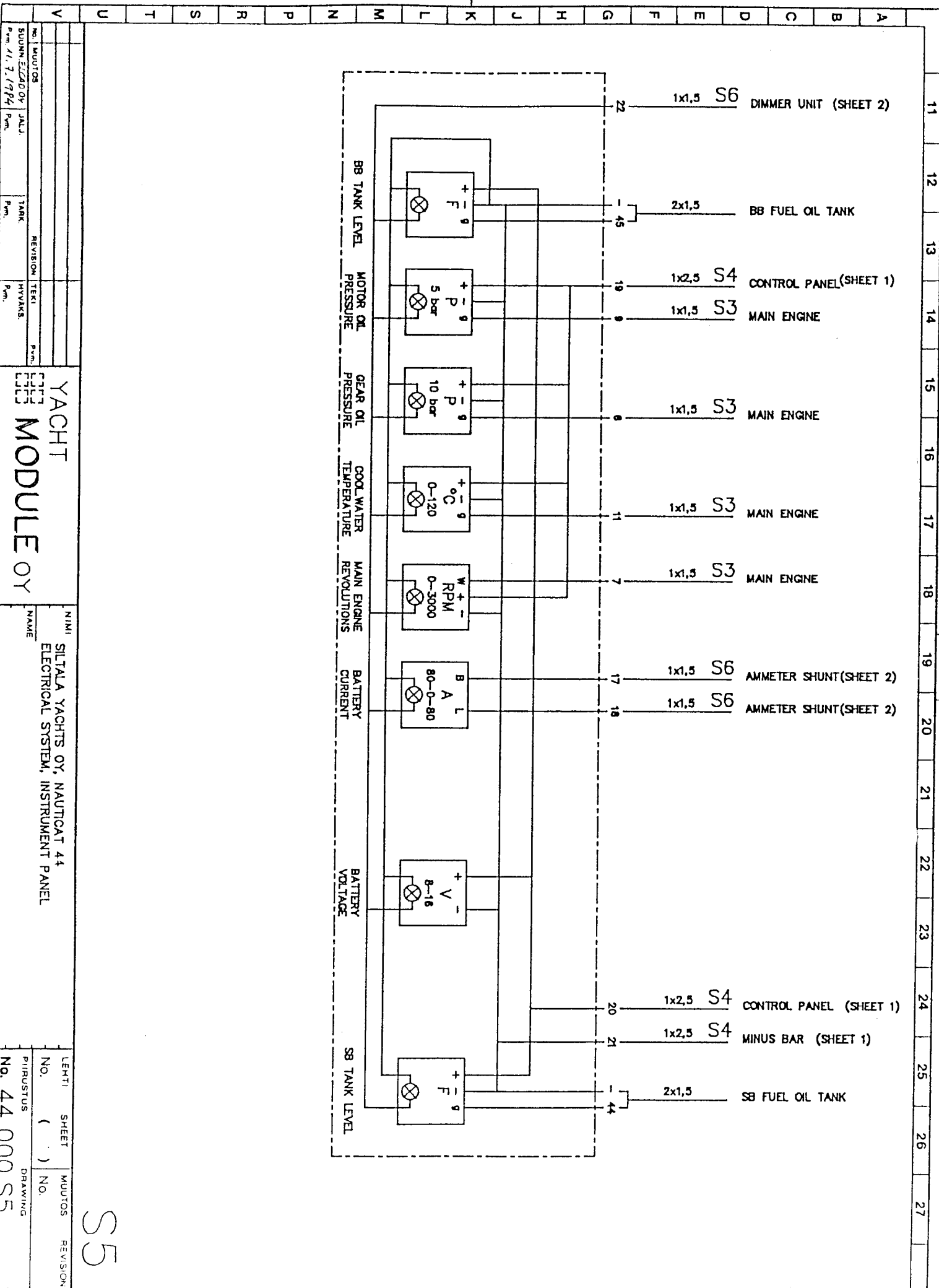

No. MUUTOS	REVISION	TEKNI	Pvm.
SUUNN. ELD. 04	JALJ.	JAAR	Pvm.
Pvm. 11.7.1994			

YACHT MODULE 04

NIMI
SILTALA YACHTS OY, NAUTICAT 44
ELECTRICAL SYSTEM, INSTRUMENT PANEL

LEHTI SHEET	MUUTOS REVISION
NO. () NO.	
PIIRUSTUS DRAWING	
No. 44.000.S5	

S5

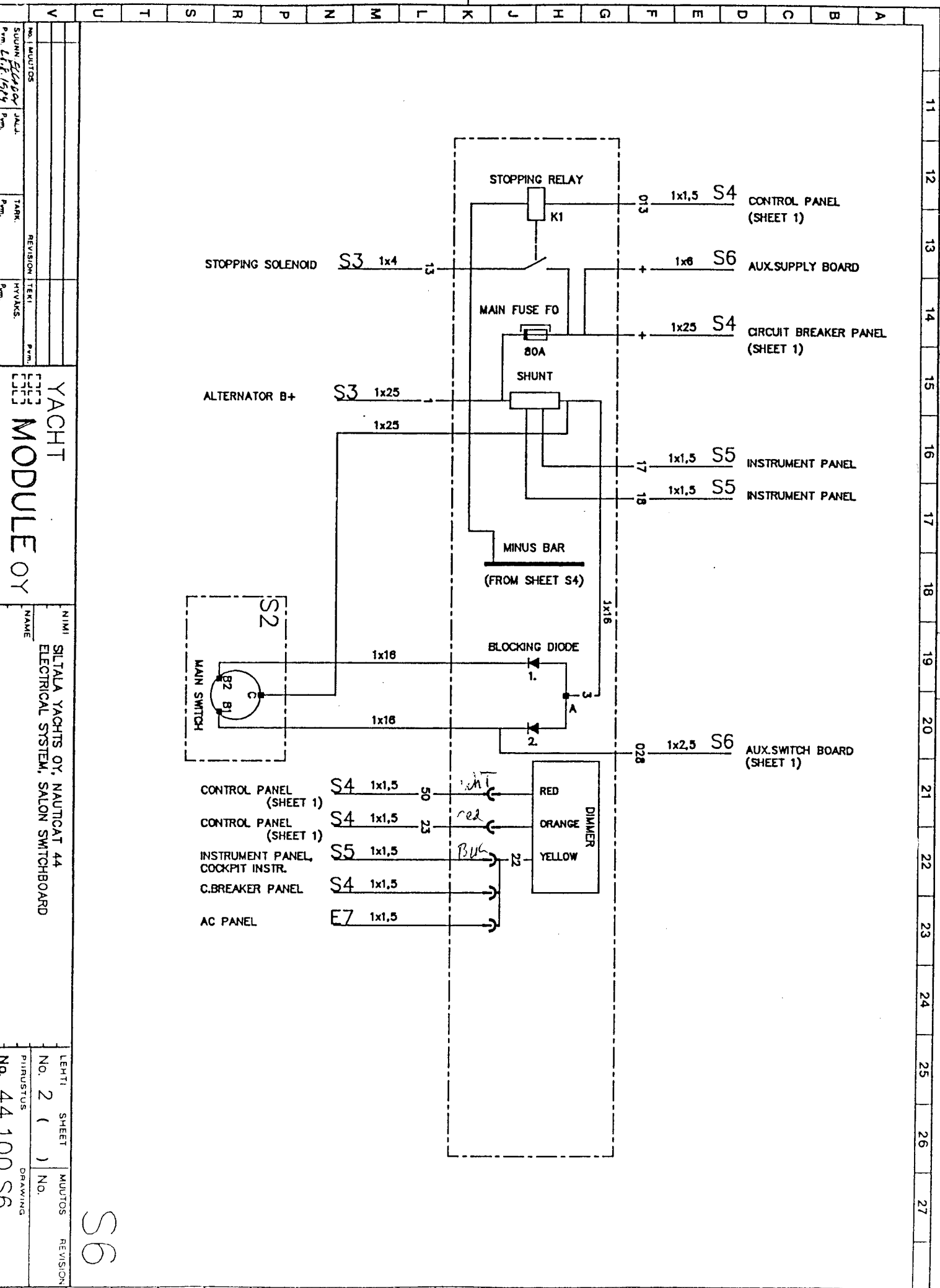

NO. MUUTOS	JAL.	TARK.	REVISION	TEKI	PVM.
SUUNN. ELOPOR.	JAL.	Pvm.			
Pvm. 1.1.1974					

YACHT
MODULE 01

NIMI
SILTALA YACHTS OY, NAUTICAT 44
ELECTRICAL SYSTEM, SALON SWITCHBOARD

LEHTI SHEET	MUUTOS REVISION
NO. 2 ()	NO.
PIIRUSTUS	DRAWING
NO. 44 100 SA	

S6

11
12
13
14
15
16
17
18
19
20
21
22
23
24
25
26
27

V U T S R P N M L K J I H G F E D C B A

11 12 13 14 15 16 17 18 19 20 21 22 23 24 25 26 27

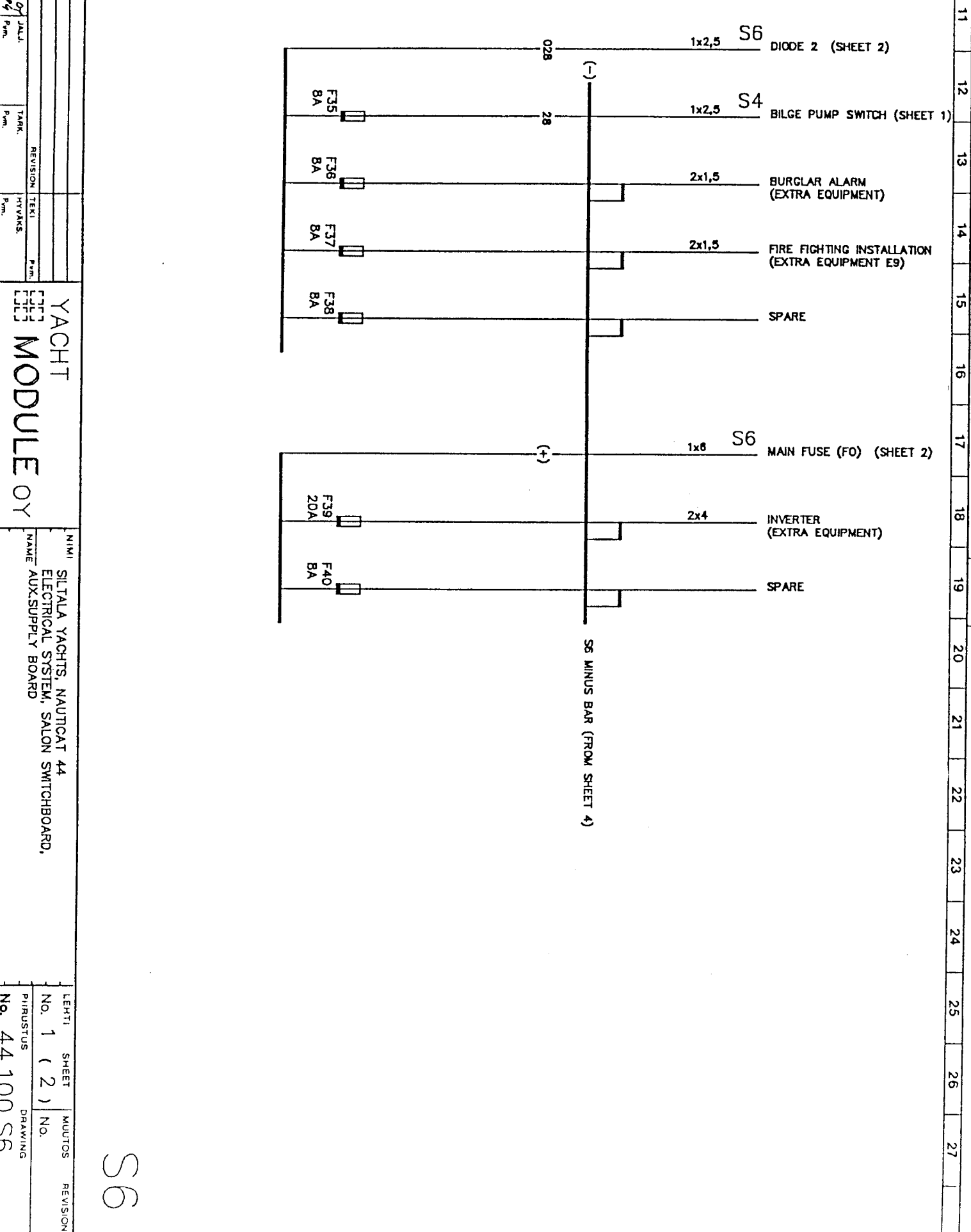

Y

YACHT
MODULE 07

NIMI SILTALA YACHTS, NAUTICAT 44
ELECTRICAL SYSTEM, SALON SWITCHBOARD,
AUX. SUPPLY BOARD

LEHTI SHEET MUUTOS REVISION
No. 1 (2) No.
PIIRUSTUS DRAWING
No. 44.100.S6

V U T S R P N M L K J I H G F E D C B A